



The CMD69423P, using patent pending technology, is an indoor, low PIM, 2-port, omni-directional, ceiling mount antenna. The antenna is designed to deliver best-in-class performance for indoor requirements, operating between 698-960 MHz and 1300-4200 MHz. The individual antenna elements are designed with linear, vertical, and horizontal components and are optimized to radiate a specifically shaped pattern for optimal performance when installed on a ceiling.

### FEATURES AND BENEFITS

- Wide bandwidth: 698-960 MHz and 1300-4200 MHz
- Services CBRS and 5G spectrum to 4200 MHz
- Low profile aesthetically-neutral housing
- Full Plenum rating
- Low port-to-port correlation, ensuring optimal MIMO performance
- Low PIM

### ELECTRICAL SPECIFICATIONS

Operating Frequency (MHz)	698-806	824 – 960	1350 – 1550	1690 – 2180	2300 – 2700	3300 - 4200
Number of Ports	2 x 2 MIMO					
VSWR – Max	2:1					
Gain (dBi) - Max	3.9	5.3	6.0	6.1	6.8	6.7
PIM - 2x20W (dBc)	< -150					
Isolation Port 1 – 2 (dB) - Max	-15	-15	-15	-16	-26	-20
Nominal Impedance (Ohms)	50					
Max Power - Ambient 25°C (W)	50					
Polarization	Linear, vertical and horizontal					
Vertical Plane 3 dB Beamwidth Port N	See radiation patterns					
Horizontal Plane 3 dB Beamwidth Port N	See radiation patterns					

### MECHANICAL SPECIFICATIONS

Dimensions – diameter x height – mm (inches)	218.7 x 43.5 (8.6 x 1.71)
Weight – g (lbs.)	430 (0.95)
Cable Length cm (in)	30 (11.8)
Radome Material	PC + ABS
Mounting	Ceiling mount (flush mount with screws and anchors)

### ENVIRONMENTAL SPECIFICATIONS

Operating Environment (Indoor or Outdoor)	Indoor
Operating Temperature – °C (°F)	-30 to +70°C (-22 to +158°F)
Storage Temperature – °C (°F)	-40 to +85°C (-22 to +158°F)
Flammability Rating	UL94-V0
Material Substance Compliance	RoHS
Standard for Safety: Information Technology Equipment	UL/CSA/EN/IEC/CB-Scheme 60950-1 Listed
Standard for Safety: Fire and Smoke (Plenum)*	UL 2043 Certified

### CONFIGURATION

PART NUMBER	CABLE LENGTH	CONNECTOR	PACKAGING
CMD69423P-30D43F	Dual 30 cm	Dual Female 4.3-10	Unit-packed
CMD69423P-30NF	Dual 30 cm	Dual Female N	Unit-packed
CMD69423P-B30D43F	Dual 30 cm	Dual Female 4.3-10	Bulk-packed
CMD69423P-B30NF	Dual 30 cm	Dual Female N	Bulk-packed

**PACKAGING INFORMATION**

PART NUMBER	DESCRIPTION
161-00155	Master carton
161-00070-B	Carton insert
161-00070-A	Unit carton

PACKAGED DIMENSIONS	CARTON	AIR PALLET	OCEAN PALLET
Number of Antennas	3	72	90
Height – cm (in.)	31.7 (12.48)	141.0 (55.51)	173.0 (68.11)
Length – cm (in.)	53.4 (21.02)	120.0 (47.24)	120.0 (47.24)
Width – cm (in.)	26.5 (10.43)	80.0 (31.50)	80.0 (31.50)
Shipping Weight – kg (lb.)		122 (270.0)	145 (320.0)

PACKAGED DIMENSIONS - BULK	CARTON	AIR PALLET	OCEAN PALLET
Number of Antennas	8	192	240
Height – cm (in.)	31.7 (12.48)	141.0 (55.51)	173.0 (68.11)
Length – cm (in.)	53.4 (21.02)	120.0 (47.24)	120.0 (47.24)
Width – cm (in.)	26.5 (10.43)	80.0 (31.50)	80.0 (31.50)
Shipping Weight – kg (lb.)		155 (341.7)	185 (407.9)

**MECHANICAL DRAWING**

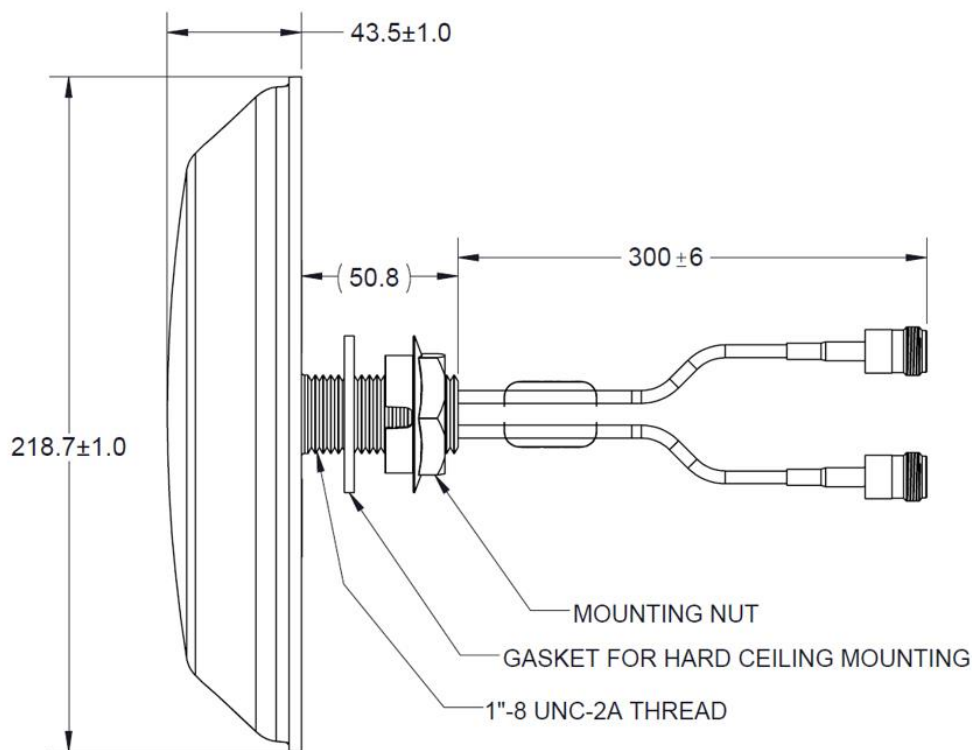

RADIATION PATTERNS

**725 MHz**

**850 MHz**

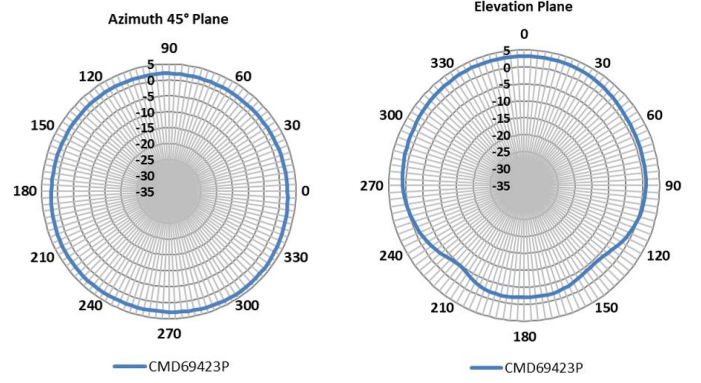
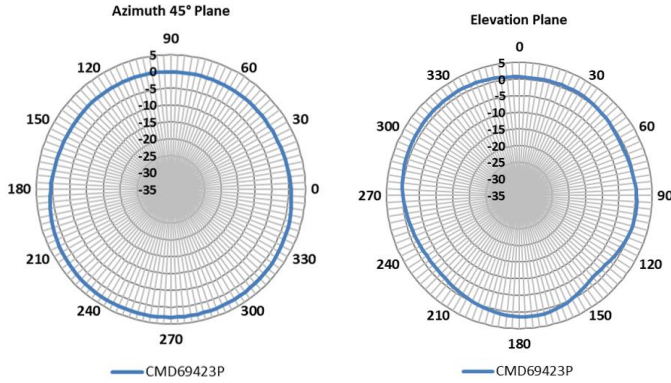

**1448 MHz**

**1730 MHz**

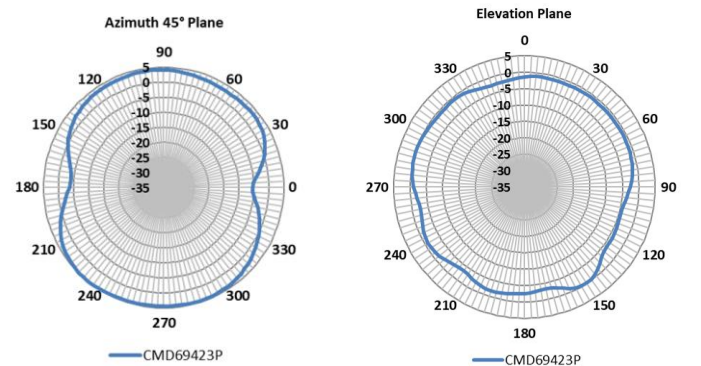
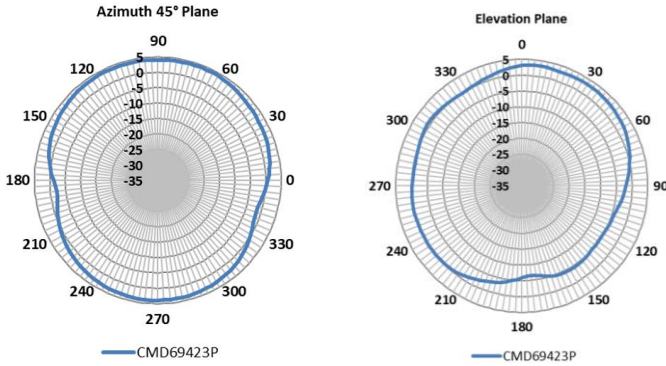

**1930 MHz**

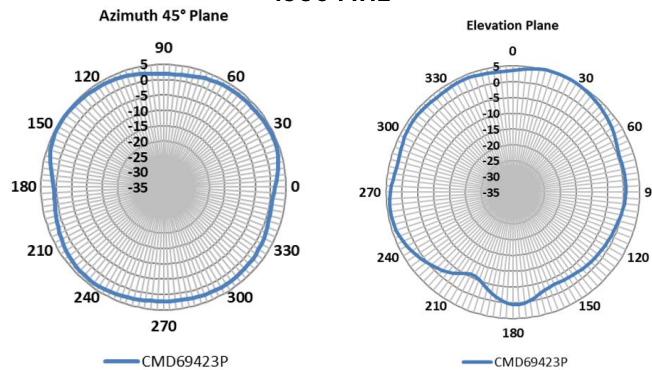

RADIATION PATTERNS

**2130 MHz**

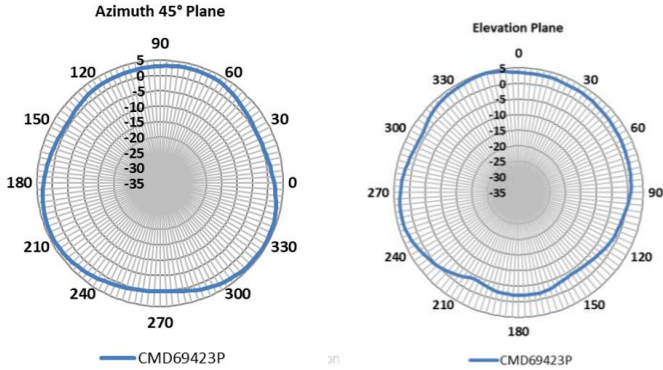

**2310 MHz**

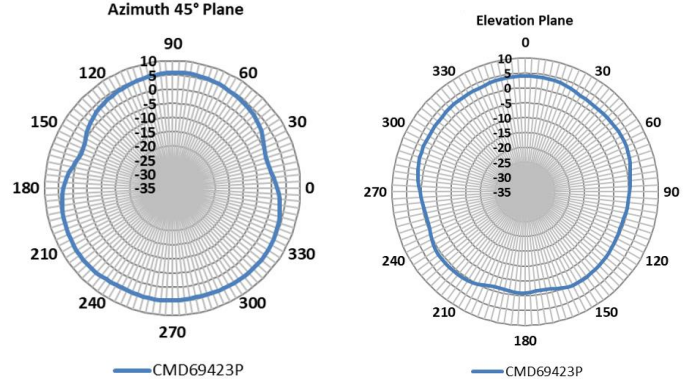

**2600 MHz**

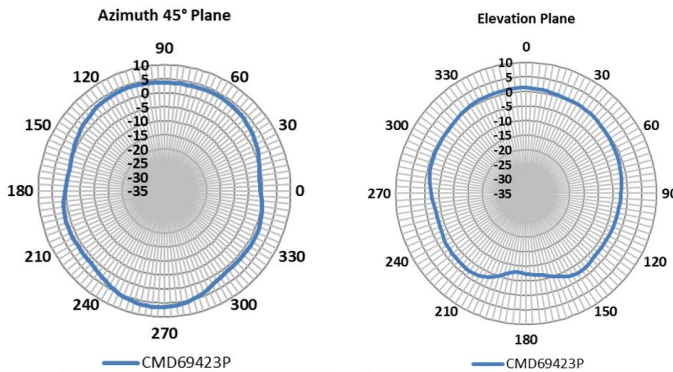

**3500 MHz**

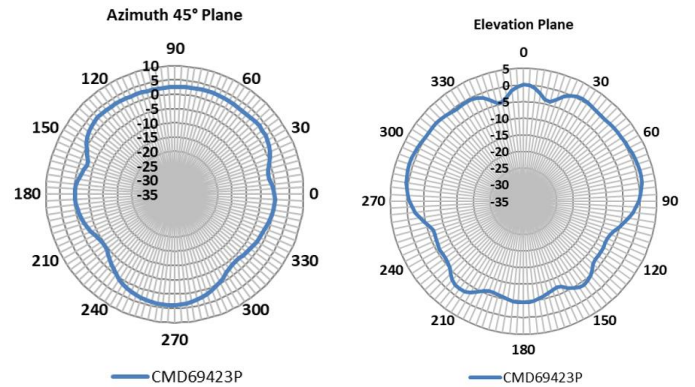

**RoHS**

Laird warrants to the original end user customer of its products that its products are free from defects in material and workmanship. Subject to conditions and limitations Laird will, at its option, either repair or replace any part of its products that prove defective because of improper workmanship or materials. This limited warranty is in force for the useful lifetime of the original end product into which the Laird product is installed. Useful lifetime of the original end product may vary but is not to exceed five (5) years from the original date of the end product purchase.

Any information furnished by Laird Inc. and its agents is believed to be accurate and reliable. All specifications are subject to change without notice. Responsibility for the use and application of Laird materials rests with the end user, since Laird and its agents cannot be aware of all potential uses. Laird makes no warranties as to the fitness, merchantability or suitability of any Laird materials or products for any specific or general uses. Laird shall not be liable for incidental or consequential damages of any kind. All Laird products are sold pursuant to the Laird Terms and Conditions of sale in effect from time to time, a copy of which will be furnished upon request.

© Copyright 2019 Laird Inc. All Rights Reserved. Laird, Laird Technologies, the Laird Logo, and other marks are trademarks or registered trademarks of Laird Inc. or an affiliate company thereof. Other product or service names may be the property of third parties. Nothing herein provides a license under any Laird or any third party intellectual property rights.



sales@lairdconnect.com  
support@lairdconnect.com  
www.lairdconnect.com